

NEW

FINE series PURE

# NEW MEGA series



FPR-NSD-721-6.35-316LP

FPR-ND-71-6.35

FUND-71G-6.35

*Safety & Clean Technology*

**Fujikin** Incorporated

NEW MEGA-ONE<sup>®</sup> LA

NEW MEGA-ONE<sup>®</sup> LS

NEW MEGA-ONE<sup>®</sup> LM



High-pressure Gas Certification

NEW MEGA-MINI LA

NEW MEGA-MINI HA

NEW MEGA-MINI HM

NEW MEGA-MINI HQ

Fujikin's Class 1 cleanrooms feature cutting-edge technology throughout, and must achieve the most rigorous standards of cleanliness. Products manufactured in this environment are guaranteed to meet the most stringent requirements and to be of the highest quality.





Every flow starts here.

# INDEX

## NEW MEGA Series

### NEW MEGA-ONE®

NEW MEGA - ONE® LA ..... 3 (Pneumatically-actuated Valves)	
NEW MEGA - ONE® LS ..... 7 (1/4 Turn Switch Valves)	
NEW MEGA - ONE® LM ..... 11 (Round-handled Valve with Indicator)	

### NEW MEGA-MINI

NEW MEGA - MINI LA ..... 15 (Compact Pneumatically-actuated Valves)	
NEW MEGA - MINI HA ..... 19 (Compact High Pressure Pneumatically-actuated Valves)	
NEW MEGA - MINI HM ..... 23 (Round-handled Valve with Indicator)	

### OPTIONS

Additional Information ..... 27	
Comparison Table ..... 28	
Part Number Designation ..... 29 (Configuration / Flow Direction / Fittings)	
Order Form ..... 33	

# NEW MEGA-ONE® LA

## New Low-pressure Pneumatically-actuated Valves

The NEW MEGA-ONE® LA is a pneumatically-actuated diaphragm valve for ultra-pure, flammable, or toxic fluid lines for all types of semiconductor equipment and facilities.

The direct diaphragm construction makes the NEW MEGA-ONE® LA an industry standard valve with superior sealing performance, remarkable durability and compactness, and particle- and dead-space-free performance.

This valve has the same performance as the MEGA-ONE® LA, but is more compact and durable.

Color-coded labels differentiate between normally open (blue) and normally closed (red) valves, thereby simplifying identification.



- The simplified actuator design makes it more compact.
- Durability of over 4 million cycles (ø6.35)

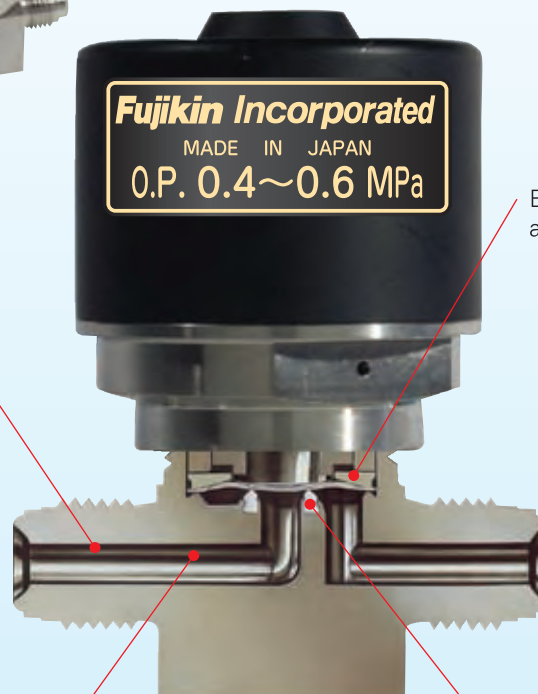

Excellent gas displacement characteristics. (1.48cc total volume for the male UJR version.)

Extremely durable nickel-cobalt alloy diaphragm

EP treatment is standard for all wetted surfaces. UP treatment is optional.

Standard seat material is PCTFE. Polyimide/PFA seat material is also available.



## Specifications and Materials

Specifications	Nominal Diameter	Maximum Operating Pressure	Fluid Temperature Range	Maximum Cv* (with N <sub>2</sub> gas at 20°C)	Actuation Pressure	Supply Air Connection	End Connection
	6.35	1 MPa	-10 to 80°C	0.3	0.4 to 0.6 MPa	M5×0.8	UJR, UPG, F900, tube stub
	9.52 & 12.7			0.65			

● Theoretical leak rate: External leak:  $< 5 \times 10^{-12}$  Pa·m<sup>3</sup>/sec. Seat leak:  $< 5 \times 10^{-12}$  Pa·m<sup>3</sup>/sec  
 ● Tested leak rate: External leak:  $< 5 \times 10^{-10}$  Pa·m<sup>3</sup>/sec. Seat leak:  $< 5 \times 10^{-10}$  Pa·m<sup>3</sup>/sec  
 ● Durability of over 4 million cycles (ø6.35), and over 2 million cycles (ø9.52), respectively, under test conditions.

● All valves are helium leak tested.  
 \* Depends on the configuration of the body.

Materials	Part	Material
	Body*	SUS316L
	Diaphragm	Nickel-cobalt alloy
	Seat	PCTFE (standard)
	Actuator	Aluminum alloy (alumite coated)

\* Materials other than SUS316L double-melt are also available. Consult with Fujikin for use outside the specification range.

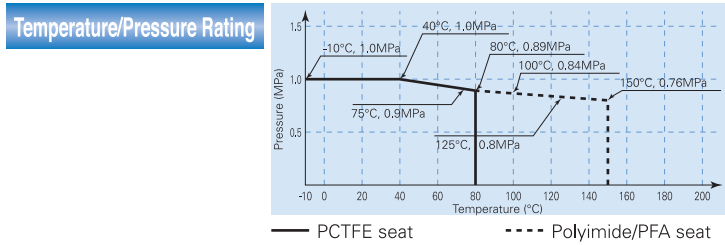

## Part Number Designation

Please use the part number designations below when placing an order.

FPR-ND [ ] -71-6.35 [ ] [ ] - [ ] - [ ]

A	B	C	D	E	F	G	H	I	J
FP: Normally open FPR: Normally closed	Stainless steel direct diaphragm valve	TB: 3-way valve* CL: 2-way, corner left valve*	7: UJR/UPG end connection 9: F900 end connection 5: Tube stub end connection	1: 1 MPa maximum operating pressure	End Connection Size 6.35: 1/4"OD 9.52: 3/8"OD 12.7: 1/2"OD (UJR connections have a 9.52mm port diameter.)	Blank: Male UJR on both ends UG: UPG end connection BW: Butt weld	-2: Female UJR on both ends -3: Male UJR inlet / Female UJR outlet	Blank: PCTFE seat PI: Polyimide seat* PA: PFA seat*	UP: UP treatment* PS: Cr <sub>2</sub> O <sub>3</sub> treatment* FD: Fluorine passivation*

\* Optional or made-to-order.

Actual shipped items may have additional designations (such as #A, #B) in the part number. These indicate production history and do not indicate a change in function or dimensions.

## Dimensions

\* For the most up-to-date product information, visit Fujikin's website (<http://www.fujikin.co.jp/>).

Figure 1

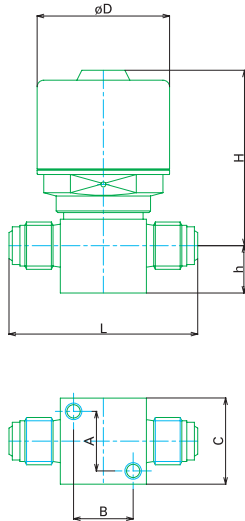

Figure 2

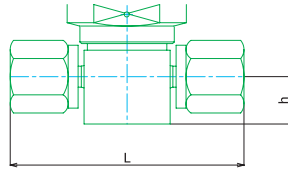

Figure 3

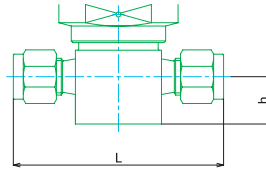

Figure 4

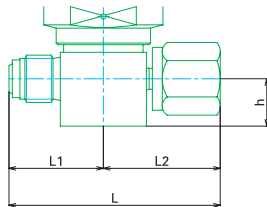

Figure 5

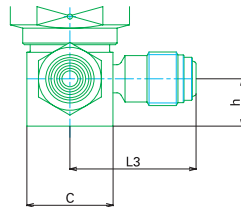
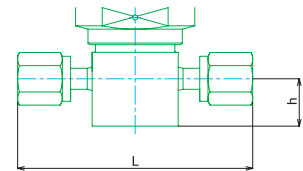

Figure 6



(Units: mm)

Part Number	Figure	L	L1	L2	L3	h	H	D	A	B	C
FP(R)-ND-71-6.35	1	57				14.3	53	40	18	18	26
FP(R)-ND-71-6.35-2	2	70.6				14.3	53	40	18	18	26
FP(R)-ND-71-9.52	1	76.2				11.1	67.5	55	20.2	20.2	35
FP(R)-ND-71-9.52-2	2	83				12.7	67.5	55	20.2	20.2	35
FP(R)-NDTB-71-6.35	4	65.7	31	34.7	38.1	14.3	54	40	18	18	26
FP(R)-NDTB-71-9.52	4	79.2	37.7	41.5	43.1	12.7	67.5	55	20.2	20.2	35
FP(R)-NDTB-71-9.52×6.35	4	69.9	31.8	38.1	38.1	12.7	66	40	18	18	26
FP(R)-ND-91-6.35	3	63.5				14.3	53	40	18	18	26
FP(R)-ND-91-9.52	3	80				12.7	67.5	55	20.2	20.2	35
FP(R)-ND-91-12.7	3	85				12.7	67.5	55	20.2	20.2	35
FP(R)-ND-71-6.35UG	5	46				14.3	53	40	18	18	26
FP(R)-ND-71-6.35UG-2	6	71				14.3	53	40	18	18	26
FP(R)-ND-71-9.52UG	5	57				11.1	67.5	55	20.2	20.2	35
FP(R)-ND-71-9.52UG-2	6	86				12.7	67.5	55	20.2	20.2	35
FP(R)-ND-71-12.7UG	5	61				11.1	67.5	55	20.2	20.2	35
FP(R)-ND-71-12.7UG-2	6	92				12.7	67.5	55	20.2	20.2	35

\* See Figure 1 for dimension keys not shown in other figures.



## OPTIONS

### Block Valve

FBNDV-6.35-2B3-DGO

Block valve design allows for:  
 - Compact tubing arrangement  
 - Dead-space-free configuration.

In addition to our standard 2-actuator, 3-port block, we also offer custom block valves according to customers' specifications.



FPR-ND-51-6.35BW-AWE

### Tube Stub Length

Customers may specify tube stub length.

### Proximity Sensor

FPR-UDDF-71RS2-9.52

An electrical signal confirms the open or closed position of the valve.  
 (MEGA Series)



FPR-UDDF-71LS-6.35-NL

### Limit Switch

An electrical signal confirms the open or closed position of the valve.  
 (MEGA Series)

### IGS Valves

FPR-UDDFA-21-6.35UGF-APD

MEGA Series valves are available for surface-mount Integrated Gas Systems.  
 (MEGA Series)



The photos on this page depict examples of each product type.

# NEW MEGA-ONE® LS

## New Low-pressure Switching Manual Valves

The NEW MEGA-ONE® LS is a quarter turn diaphragm valve for ultra-pure, flammable, or toxic fluid lines in semiconductor manufacturing equipment and facilities.

Unique features include an internal spring that assures uniform sealing performance and a direct diaphragm construction that makes the NEW MEGA-ONE® LS an industry standard valve with superior sealing performance, remarkable durability, compactness, and particle- and dead-space-free performance. This valve's redesigned handle increases ease of use.

- Valve open or closed position is visible at a glance.
- User-friendly handle.
- Durability of over 20,000 cycles.

Different color handles are available to facilitate fluid identification.

Panel mount model available.

Excellent gas displacement characteristics. (1.48cc total volume for the male 6.35 UJR version.)

EP treatment is standard for all wetted surfaces. UP treatment is optional.

Valve open or closed position is easily visible at a glance.

1. Accurate valve position indicator



2. Flow indicators prevent misoperation.

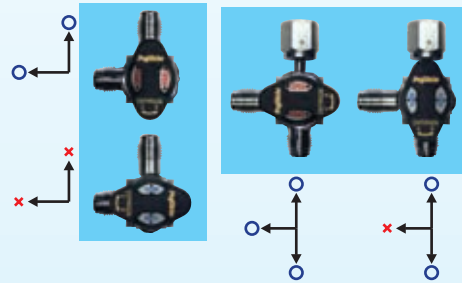

Highly durable nickel-cobalt alloy diaphragm.

Standard seat material is PCTFE. Polyimide/PFA seat material is also available.

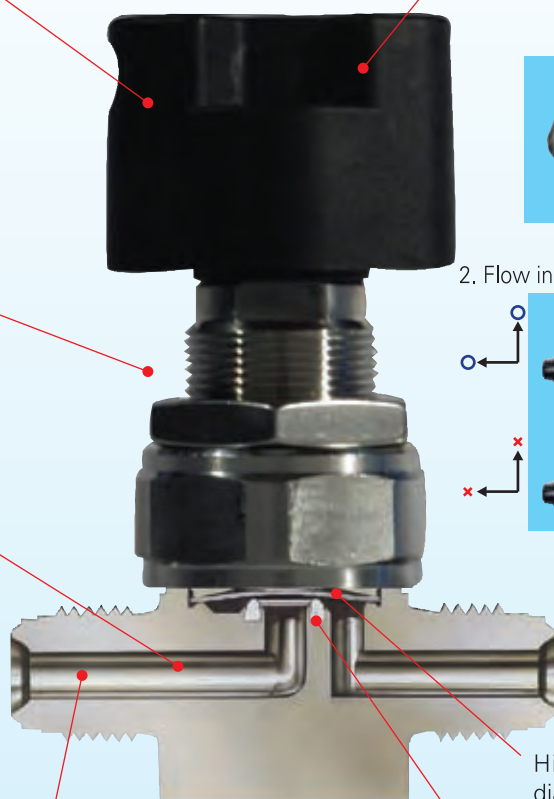





## Specifications and Materials

Specifications	Nominal Diameter	Maximum Operating Pressure	Fluid Temperature Range	Maximum Cv* (with N <sub>2</sub> gas at 20°C)	End Connection
	6.35	1 MPa	-10 to 80°C	0.3	UJR, UPG, F900, tube stub
	9.52 & 12.7			0.65	

● Theoretical leak rate: External leak:  $< 5 \times 10^{-12}$  Pa·m<sup>3</sup>/sec. Seat leak:  $< 5 \times 10^{-12}$  Pa·m<sup>3</sup>/sec  
 ● Tested leak rate: External leak:  $< 5 \times 10^{-10}$  Pa·m<sup>3</sup>/sec. Seat leak:  $< 5 \times 10^{-10}$  Pa·m<sup>3</sup>/sec  
 \* Depends on the configuration of the body.

● All valves are helium leak tested.  
 ● Durability of over 20,000 cycles under test conditions.

Materials	Part	Material
	Body*	SUS316L
	Diaphragm	Nickel-cobalt alloy
	Seat Packing	PCTFE (standard)
	Handle	Nylon 6

\* Materials other than SUS316L double-melt are also available.  
 Consult with Fujikin for use outside the specification range.

### Temperature/Pressure Rating

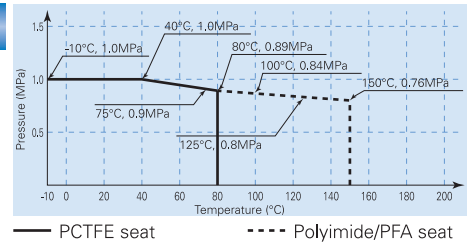

## Part Number Designation

Please use the part number designations below when placing an order.

**FUND L** [ ] -71G -6.35 [ ] [ ] - [ ] - [ ]

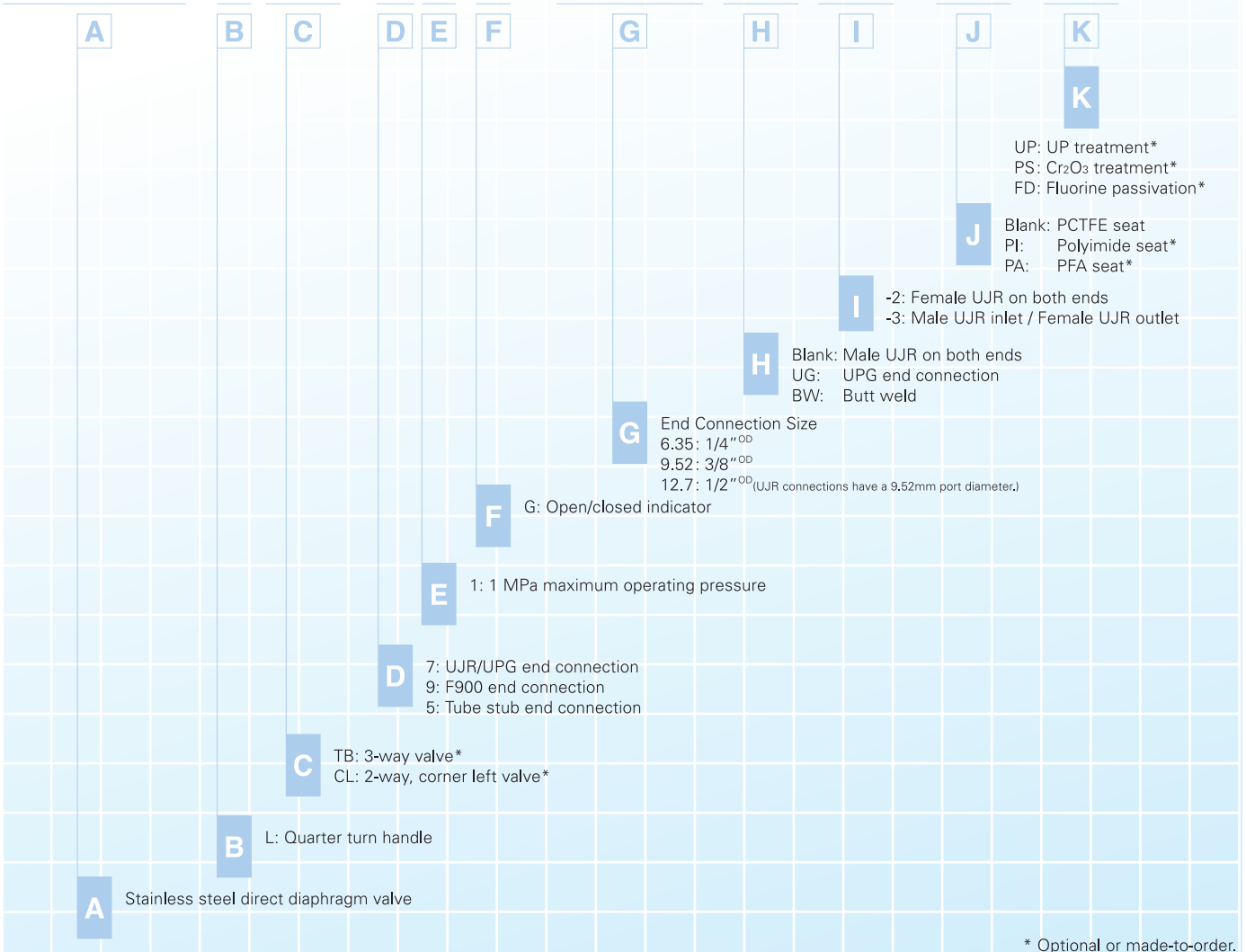

\* Optional or made-to-order.

Actual shipped items may have additional designations (such as #A, #B) in the part number. These indicate production history and do not indicate a change in function or dimensions.

## Dimensions

\* For the most up-to-date product information, visit Fujikin's website (<http://www.fujikin.co.jp/>).

Figure 1

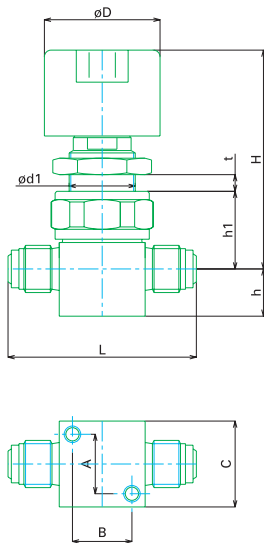

Figure 2

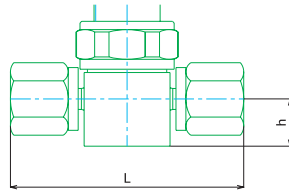

Figure 3

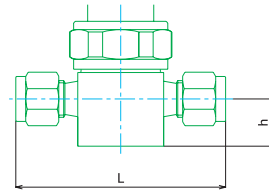

Figure 4

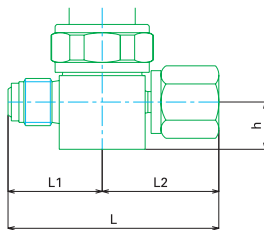

Figure 5

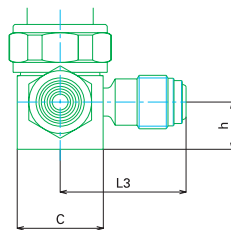
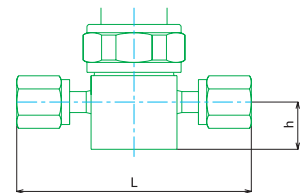

Figure 6



(Units: mm)

Part Number	Figure	L	L1	L2	L3	h	H	h1	d1	t	D	A	B	C
FUNDL-71G-6.35	1	57				14.3	66.3	23.5	20.5	7	35	18	18	26
FUNDL-71G-6.35-2	2	70.6				14.3	66.3	23.5	20.5	7	35	18	18	26
FUNDL-71G-9.52	1	76.2				11.1	85.3	31.5	24.5	10	46	20.2	20.2	35
FUNDL-71G-9.52-2	2	83				12.7	85.3	31.5	24.5	10	46	20.2	20.2	35
FUNDLTB-71G-6.35	4	65.7	31	34.7	38.1	14.3	67.3	24.5	20.5	7	35	18	18	26
FUNDLTB-71G-9.52	4	79.2	37.7	41.5	43.1	12.7	87.5	31.5	24.5	10	46	20.2	20.2	35
FUNDLTB-71G-9.52×6.35	4	69.9	31.8	38.1	38.1	12.7	70.8	28	20.5	7	35	18	18	26
FUNDL-91G-6.35	3	63.5				14.3	66.3	23.5	20.5	7	35	18	18	26
FUNDL-91G-9.52	3	80				12.7	85.3	31.5	24.5	10	46	20.2	20.2	35
FUNDL-91G-12.7	3	85				12.7	85.3	31.5	24.5	10	46	20.2	20.2	35
FUNDL-71G-6.35UG	5	46				14.3	66.3	23.5	20.5	7	35	18	18	26
FUNDL-71G-6.35UG-2	6	71				14.3	66.3	23.5	20.5	7	35	18	18	26
FUNDL-71G-9.52UG	5	57				11.1	85.3	31.5	24.5	10	46	20.2	20.2	35
FUNDL-71G-9.52UG-2	6	86				12.7	85.3	31.5	24.5	10	46	20.2	20.2	35

\* See Figure 1 for dimension keys not shown in other figures.



**OPTIONS**

**Handle Colors** GT-HL-FUNPL\*

A letter in place of "\*" indicates handle color:  
Blue=B, Green=G, Yellow=Y, and Red=R

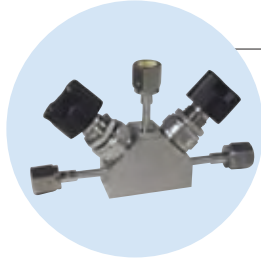

FBNDV-6.35-OB3-2P-DGO

**Block Valve**

Block valve design allows for:  
- Compact tubing arrangement  
- Dead-space-free configuration.

In addition to our standard 2-actuator, 3-port block, we also offer custom block valves according to customers' specifications.

**Toggle Valve**

FUNSDBCK-21G-6.35UGC

The handle for this valve can be toggled with a single touch. This option is ideal for valves that are opened and closed frequently.



**Integrated Lock-out / Tag-out (LOTO) Valve** FUNDL-71GT-6.35

This option may be selected as a safety precaution. This valve incorporates an open/close indicator into the LOTO device.



FUDDFL-21-6.35UGF-APD

**IGS Valves**

MEGA Series valves are available for surface-mount Integrated Gas Systems. (MEGA Series)

The photos on this page depict examples of each product type.

# NEW MEGA-ONE® LM

## New Low-pressure Manual Valve

The NEW MEGA-ONE® LM offers manual operation for ultra-pure, flammable, or toxic fluid lines in semiconductor manufacturing equipment and facilities.

Direct diaphragm construction makes the NEW MEGA-ONE® LM an industry standard valve with superior sealing performance, remarkable durability, compactness, and particle- and dead-space-free performance.

This valve has the same performance as the MEGA-ONE® LM, but is more compact and durable.

● **Efficient and compact**

Other handle colors are available.

Valve open or closed position is easily visible at a glance.



Open

Closed

Excellent gas displacement characteristics.  
(1.48cc total volume for the male UJR version.)

\* The panel nut has been eliminated in this simplified, compact design.

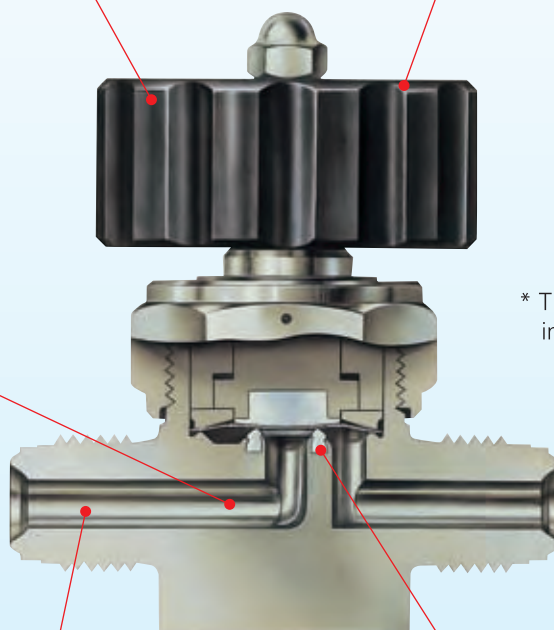

EP treatment is standard for all wetted surfaces.  
UP treatment is optional.

Standard seat material is PCTFE.  
Polyimide/PFA seat material is also available.



## Specifications and Materials

Specifications	Nominal Diameter	Maximum Operating Pressure	Fluid Temperature Range	Maximum Cv* (with N <sub>2</sub> gas at 20°C)	End Connection
	6.35	1 MPa	-10 to 80°C	0.3	UJR, UPG, F900, tube stub
	9.52 & 12.7			0.65	

● Theoretical leak rate: External leak:  $< 5 \times 10^{-12}$  Pa·m<sup>3</sup>/sec. Seat leak:  $< 5 \times 10^{-12}$  Pa·m<sup>3</sup>/sec  
 ● Tested leak rate: External leak:  $< 5 \times 10^{-10}$  Pa·m<sup>3</sup>/sec. Seat leak:  $< 5 \times 10^{-10}$  Pa·m<sup>3</sup>/sec  
 \* Depends on the configuration of the body.

● All valves are helium leak tested.  
 ● Durability of over 100,000 cycles under test conditions.

Materials	Part	Material
	Body*	SUS316L
	Diaphragm	Nickel-cobalt alloy
	Seat Packing	PCTFE (standard)
	Handle	ADC12

\* Materials other than SUS316L double-melt are also available.  
 Consult with Fujikin for use outside the specification range.

### Temperature/Pressure Rating

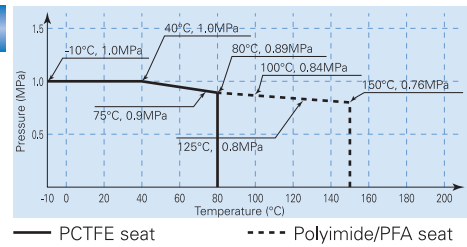

## Part Number Designation

Please use the part number designations below when placing an order.

**FUND** [ ] -71G -6.35 [ ] [ ] - [ ] - [ ]

A	B	C	D	E	F	G	H	I	J
Stainless steel direct diaphragm valve	XB: 4-way valve TB: 3-way valve* CL: 2-way, corner left valve*	7: UJR/UPG end connection 9: F900 end connection 5: Tube stub end connection	1: 1 MPa maximum operating pressure	G: Open/closed indicator	End Connection Size 6.35: 1/4"OD 9.52: 3/8"OD 12.7: 1/2"OD (UJR connections have a 9.52mm port diameter.)	Blank: Male UJR on both ends UG: UPG end connection BW: Butt weld	-2: Female UJR on both ends -3: Male UJR inlet / Female UJR outlet	Blank: PCTFE seat PI: Polyimide seat* PA: PFA seat*	UP: UP treatment* PS: Cr <sub>2</sub> O <sub>3</sub> treatment* FD: Fluorine passivation*

\* Optional or made-to-order.

Actual shipped items may have additional designations (such as #A, #B) in the part number. These indicate production history and do not indicate a change in function or dimensions.

## Dimensions

\* For the most up-to-date product information, visit Fujikin's website (<http://www.fujikin.co.jp/>).

Figure 1

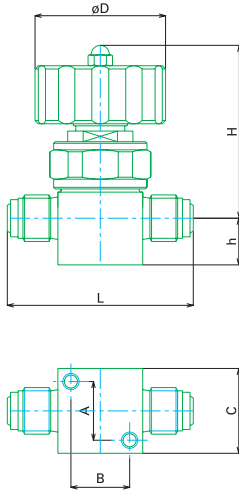

Figure 2

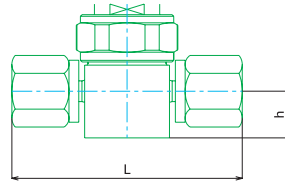

Figure 3

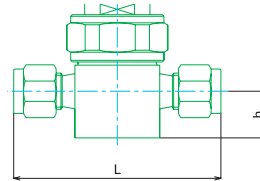

Figure 4

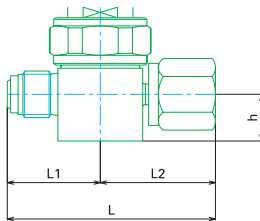

Figure 5

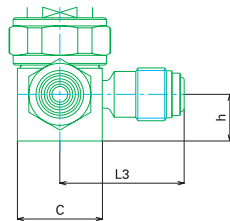
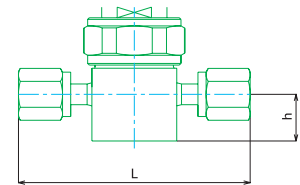

Figure 6



(Units: mm)

Part Number	Figure	L	L1	L2	L3	h	H	D	A	B	C
FUND-71G-6.35	1	57				14.3	53	40	18	18	26
FUND-71G-6.35-2	2	70.6				14.3	53	40	18	18	26
FUND-71G-9.52	1	76.2				11.1	60.8	40	20.2	20.2	35
FUND-71G-9.52-2	2	83				12.7	60.8	40	20.2	20.2	35
FUNDTB-71G-6.35	4	65.7	31	34.7	38.1	14.3	54	40	18	18	26
FUNDTB-71G-9.52	4	79.2	37.7	41.5	43.1	12.7	60.8	40	20.2	20.2	35
FUNDTB-71G-9.52×6.35	4	69.9	31.8	38.1	38.1	12.7	60.8	40	18	18	26
FUND-91G-6.35	3	63.5				14.3	53	40	18	18	26
FUND-91G-9.52	3	80				12.7	60.8	40	20.2	20.2	35
FUND-91G-12.7	3	85				12.7	60.8	40	20.2	20.2	35
FUND-71G-6.35UG	5	46				14.3	53	40	18	18	26
FUND-71G-6.35UG-2	6	71				14.3	53	40	18	18	26
FUND-71G-9.52UG	5	57				11.1	60.8	40	20.2	20.2	35
FUND-71G-9.52UG-2	6	86				12.7	60.8	40	20.2	20.2	35
FUND-71G-12.7UG	5	61				11.1	60.8	40	20.2	20.2	35
FUND-71G-12.7UG-2	6	92				12.7	60.8	40	20.2	20.2	35

\* See Figure 1 for dimension keys not shown in other figures.



## OPTIONS

### Handle Colors GT-HL-FUND-\*

A letter in place of "\*" indicates handle color:  
Blue=B, Green=G, Yellow=Y, and Red=R



FBNDL-6.35-0B3-2P-CJL

### Block Valve

Block valve design allows for:

- Compact tubing arrangement
- Dead-space-free configuration.

In addition to our standard 2-actuator, 3-port block, we also offer custom block valves according to customers' specifications.

### 3-Port Distribution Valve FUNDTB-51G-12.7×9.52JR-FHZ

Used for facility bulk gas lines, and can support all line sizes.

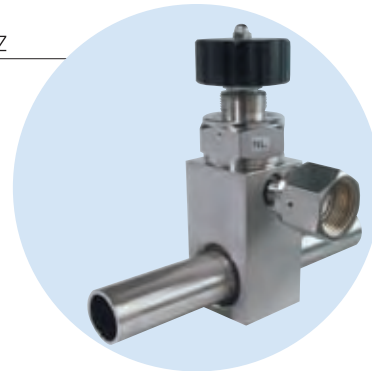

FUND-51G-6.35BW-KAG

### Tube Stub Length

Customers may specify tube stub length.

### Combination 3-way Corner Valve

Compared to the conventional block valve, the combination 3-way corner valve offers a shorter delivery time and reduced cost.

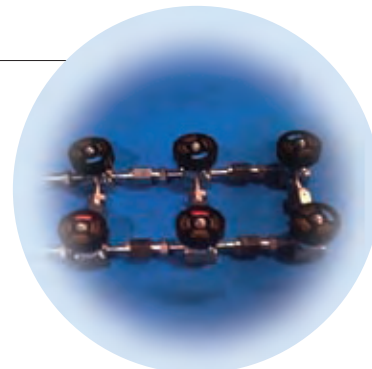

The photos on this page depict examples of each product type.

# NEW MEGA-MINI LA

## New Compact Low-pressure Pneumatically-actuated Valve

The NEW MEGA-MINI LA offers pneumatic operation for ultra-pure, flammable, or toxic fluid lines in semiconductor manufacturing equipment and facilities.

Direct diaphragm construction makes the NEW MEGA-MINI LA an industry standard valve with superior sealing performance, remarkable durability, compactness, and particle- and dead-space-free performance.

This valve has the same performance as the MEGA-MINI LA, but is more compact and durable.

Color-coded labels differentiate between normally open (blue) and normally closed (red) valves, thereby simplifying identification.



- The simplified actuator design makes it more compact.
- Durability of over 4 million cycles.

Compact Ø35 actuator offers space savings without sacrificing performance.



Excellent gas displacement characteristics.  
(0.84cc total volume for the 6.35 male UJR version.)

Highly durable nickel-cobalt alloy diaphragm.

EP treatment is standard for all wetted surfaces.  
UP treatment is optional.

Standard seat material is PCTFE.  
Polyimide/PFA seat material is also available.





## Specifications and Materials

Specifications	Nominal Diameter	Maximum Operating Pressure	Fluid Temperature Range	Maximum Cv* (with N <sub>2</sub> gas at 20°C)	Actuation Pressure	Supply Air Connection	End Connection
	3.2	1 MPa	-10 to 80°C	0.05	0.4 to 0.6 MPa	M5×0.8	UJR, UPG, F900, tube stub
	6.35			0.1			

- Theoretical leak rate: External leak:  $< 5 \times 10^{-12}$  Pa·m<sup>3</sup>/sec. Seat leak:  $< 5 \times 10^{-12}$  Pa·m<sup>3</sup>/sec
- Tested leak rate: External leak:  $< 5 \times 10^{-10}$  Pa·m<sup>3</sup>/sec. Seat leak:  $< 5 \times 10^{-10}$  Pa·m<sup>3</sup>/sec
- \* Depends on the configuration of the body.
- All valves are helium leak tested.
- Durability of over 4 million cycles under test conditions.

Materials	Part	Material
	Body*	SUS316L
	Diaphragm	Nickel-cobalt alloy
	Seat Packing	PCTFE (standard)
	Actuator	Aluminum alloy (alumite coated)

\* Materials other than SUS316L double-melt are also available. Consult with Fujikin for use outside the specification range.

### Temperature/Pressure Rating

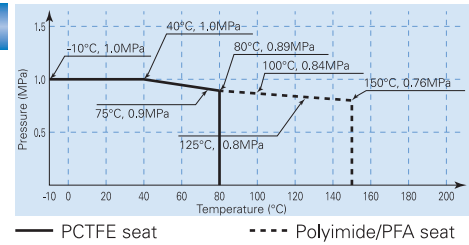

## Part Number Designation

Please use the part number designations below when placing an order.

FPR-NSD [ ] -71-6.35 [ ] [ ] - [ ] - [ ]

A	B	C	D	E	F	G	H	I	J
FP: Normally open FPR: Normally closed	Stainless steel compact direct diaphragm valve	TB: 3-way valve* CL: 2-way, corner left valve*	7: UJR/UPG end connection 5: Tube stub end connection	1: 1 MPa maximum operating pressure	End Connection Size 3.2: 1/8"OD 6.35: 1/4"OD	Blank: Male UJR on both ends UG: UPG end connection BW: Butt weld	-2: Female UJR on both ends -3: Male UJR inlet / Female UJR outlet	Blank: PCTFE seat PI: Polyimide seat* PA: PFA seat*	UP: UP treatment* PS: Cr <sub>2</sub> O <sub>3</sub> treatment* FD: Fluorine passivation*

\* Optional or made-to-order.

Actual shipped items may have additional designations (such as #A, #B) in the part number. These indicate production history and do not indicate a change in function or dimensions.

## Dimensions

\* For the most up-to-date product information, visit Fujikin's website (<http://www.fujikin.co.jp/>).

Figure 1

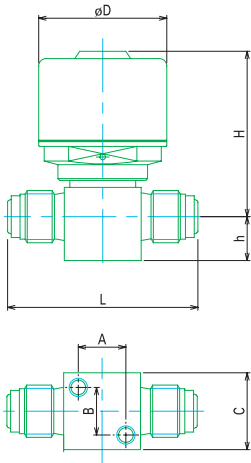

Figure 2

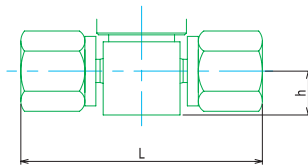

Figure 3

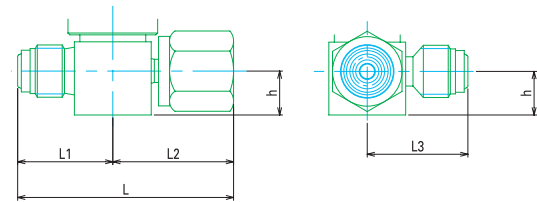

Figure 4

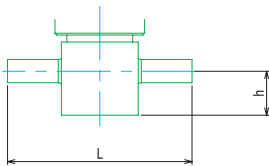

Figure 5

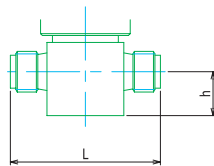
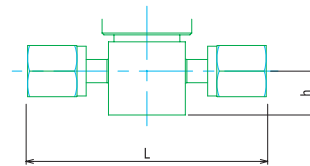

Figure 6



(Units: mm)

Part Number	Figure	L	L1	L2	L3	h	H	D	A	B	C
FP(R)-NSD-71-6.35	1	52				12	45.2	35	13	13	21
FP(R)-NSD-71-6.35-2	2	66				12	45.2	35	13	13	21
FP(R)-NSDTB-71-6.35	3	59	26	33	27.5	12	45.2	35	13	13	21
FP(R)-NSD-51-6.35BW-AWE	4	51				12	45.2	35	13	13	21
FP(R)-NSD-71-6.35UG	5	41				12	45.2	35	13	13	21
FP(R)-NSD-71-6.35UG-2	6	66				12	45.2	35	13	13	21
FP(R)-NSD-71-3.2UG	5	41				12	45.2	35	13	13	21
FP(R)-NSD-71-3.2UG-2	6	67				12	45.2	35	13	13	21

\* See Figure 1 for dimension keys not shown in other figures.



**OPTIONS**

**1/8" UPG Automatic Valve**

FPR-NSD-71-3.2UG

Ideal for low-volume lines. Dead-space-free 1/8" UPG end connection.



FBNSPW-2B3-000

**1/8" UPG Block Valve**

Block valve design allows for:

- Compact tubing arrangement
- Dead-space-free configuration.

In addition to our standard 2-actuator, 3-port block, we also offer custom block valves according to customers' specifications.

**Proximity Sensor**

FPR-SD-71RS2-6.35

An electrical signal confirms the open or closed position of the valve.

The non-contact proximity sensor offers unsurpassed safety.  
(MEGA Series)



FPR-SD-71LS-6.35

**Limit Switch**

An electrical signal confirms the open or closed position of the valve.  
(MEGA Series)

**IGS Valves**

FPR-SDA-21-6.35UGF-APD

MEGA Series valves are available for surface-mount Integrated Gas Systems.  
(MEGA Series)

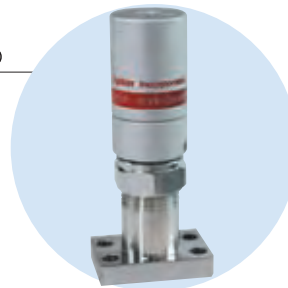

The photos on this page depict examples of each product type.

# NEW MEGA-MINI HA

## New Compact High-pressure Pneumatically Actuated Valve

The NEW NEW MEGA-MINI HA offers pneumatic operation for high-pressure ultra-pure, flammable, or toxic fluid lines in semiconductor manufacturing equipment and facilities.

Direct diaphragm construction makes the NEW MEGA-MINI HA an industry standard valve with superior sealing performance, remarkable durability, compactness, and particle- and dead-space-free performance.

This valve has the same performance as the MEGA-MINI HA, but is more compact and durable.

- The simplified actuator design makes it more compact.
- Durability of over 400,000 cycles.
- Valves with **high-pressure gas certification** available.

Excellent gas displacement characteristics.  
(0.92cc total volume for the male UJR version.)

EP treatment is standard for all wetted surfaces.



Unique actuator design results in a highly-compact pneumatic valve for high-pressure applications.

Highly durable nickel-cobalt alloy diaphragm.

Standard seat material is PCTFE. Polyimide seat material is also available.



## Specifications and Materials

Specifications	Nominal Diameter	Maximum Operating Pressure	Fluid Temperature Range	Maximum Cv* (with N <sub>2</sub> gas at 20°C)	Actuation Pressure	Supply Air Connection	End Connection
	3.2	20.5 MPa	-10 to 40°C	0.05	0.4 to 0.6 MPa	M5×0.8	UJR, UPG, tube stub
	6.35			0.1			

● Theoretical leak rate: External leak: <math>5 \times 10^{-12}</math> Pa·m<sup>3</sup>/sec. Seat leak: <math>5 \times 10^{-12}</math> Pa·m<sup>3</sup>/sec  
 ● Tested leak rate: External leak: <math>5 \times 10^{-10}</math> Pa·m<sup>3</sup>/sec. Seat leak: <math>5 \times 10^{-10}</math> Pa·m<sup>3</sup>/sec  
 \* Depends on the configuration of the body.

● All valves are helium leak tested.  
 ● Durability of over 4 million cycles under test conditions.

Materials	Part	Material
	Body*	SUS316L (double-melt)
	Diaphragm	Nickel-cobalt alloy
	Seat Packing	PCTFE (standard)
	Actuator	Aluminum alloy (alumite coated)

Consult with Fujikin for use outside the specification range.

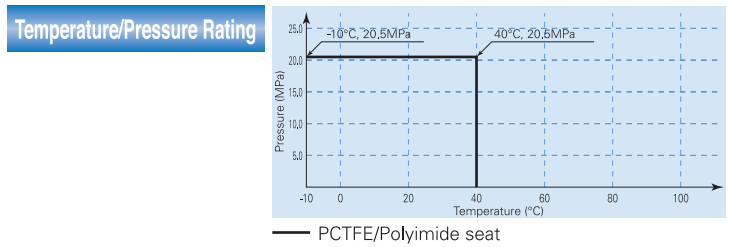

## Part Number Designation

Please use the part number designations below when placing an order.

FPR-NSD [ ] -7 21-6.35 [ ] [ ] -316LP- [ ] - [ ]

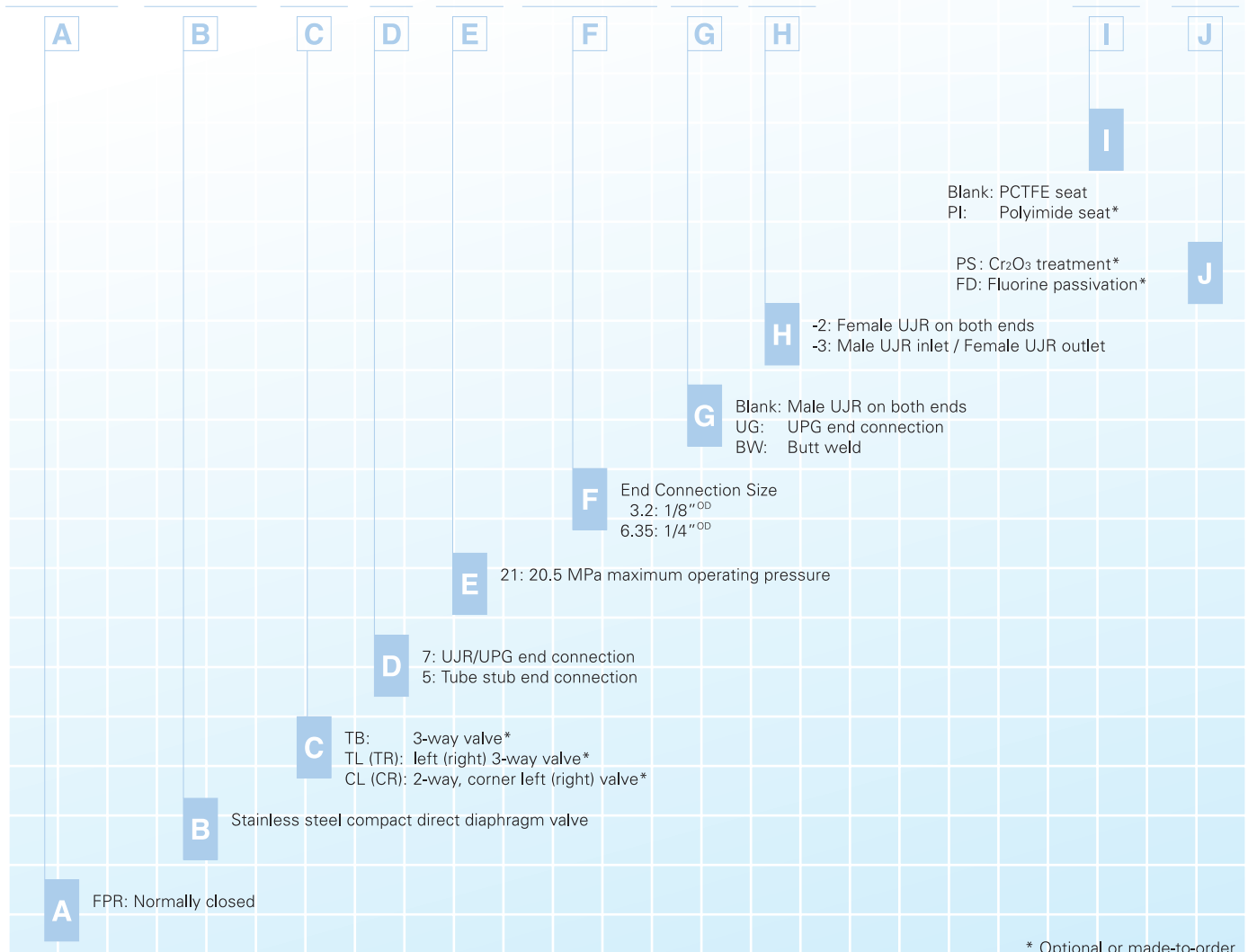

Actual shipped items may have additional designations (such as #A, #B) in the part number. These indicate production history and do not indicate a change in function or dimensions.

## Dimensions

\* For the most up-to-date product information, visit Fujikin's website (<http://www.fujikin.co.jp/>).

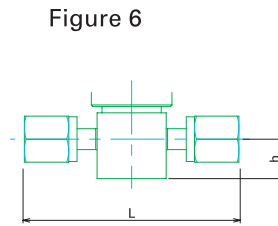
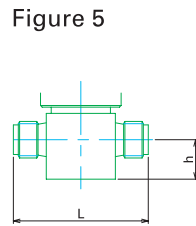
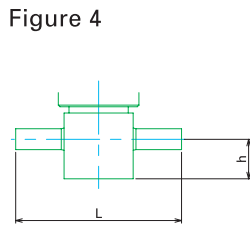
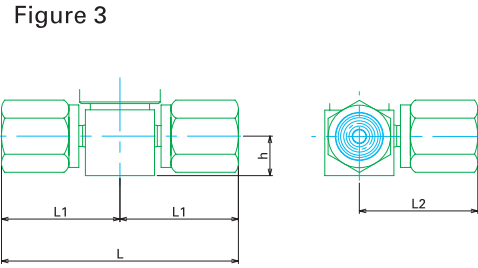
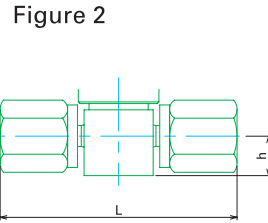
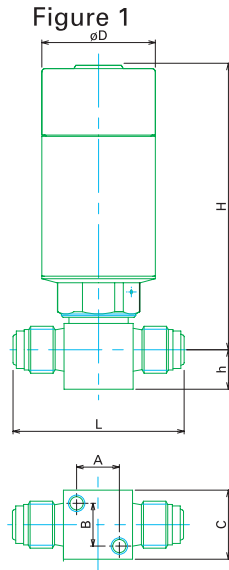

(Units: mm)

Part Number	Figure	L	L1	L2	L3	h	H	D	A	B	C
FPR-NSD-721-6.35-316LP	1	52	-	-	-	11.1	87.1	34	13	13	21
FPR-NSD-721-6.35-2-316LP	2	71.6	-	-	-	11.1	87.1	34	13	13	21
FPR-NSDTB-721-6.35-2-316LP	3	71.6	-	-	35.8	11.1	87.1	34	13	13	21
FPR-NSD-521-6.35BW-316LP-AWE	4	51	-	-	-	11.1	87.1	34	13	13	21
FPR-NSD-721-6.35UG	5	41	-	-	-	11.1	87.1	34	13	13	21
FPR-NSD-721-6.35UG-2	6	66	-	-	-	11.1	87.1	34	13	13	21
FPR-NSD-721-3.2UG	5	41	-	-	-	11.1	87.1	34	13	13	21
FPR-NSD-721-3.2UG-2	6	67	-	-	-	11.1	87.1	34	13	13	21

\* See Figure 1 for dimension keys not shown in other figures.

## OPTIONS

### High-pressure Gas Certification

Safety is assured for special high-pressure and toxic gas lines. This valve is tested and approved by the Japanese government agency that regulates high-pressure applications. The valve couplings (N-II) can also be certified and approved in the same manner.

Specific customer specifications may also be accommodated.

\* Use the order specification for recognized high-pressure gas products on page 33 to place orders.



The photos on this page depict examples of each product type.



# Standard Configurations

\* Flow Diagrams (top view)

## Corner Valves

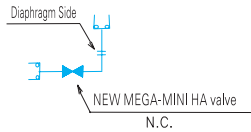

FPR-NSDCL-721-6.35-2-316LP

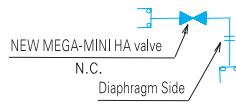

FPR-NSDCR-721-6.35-2-316LP



## 3-way Valves

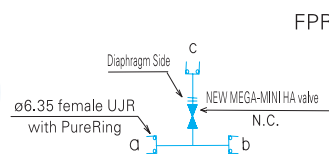

FPR-NSDTB-721-6.35-2-316LP

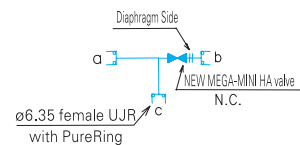

FPR-NSDTR-721-6.35-2-316LP

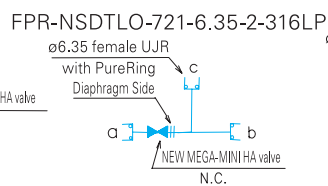

FPR-NSDTLO-721-6.35-2-316LP

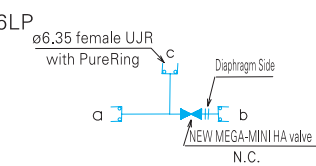

FPR-NSDTL-721-6.35-2-316LP

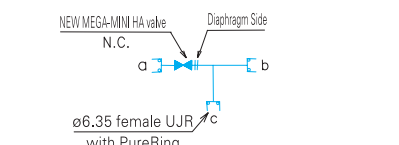

FPR-NSDTRO-721-6.35-2-316LP

## 4-way Valves

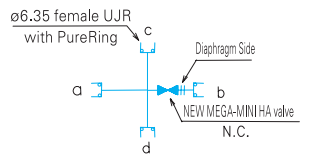

FPR-NSDXT-721-6.35-2-316LP

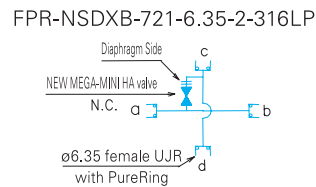

FPR-NSDXB-721-6.35-2-316LP



## Block Valves

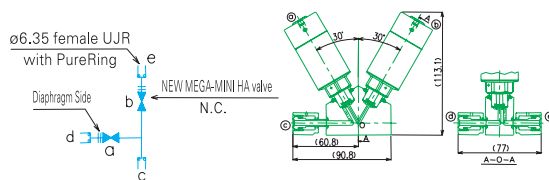

FBNSDV-721-6.35-2B3-316LP-BHB

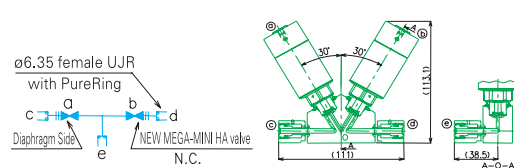

FBNSDV-721-6.35-2B3-316LP-BHM

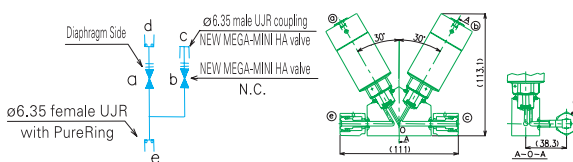

FBNSDV-721-6.35-2B3-316LP-BHJ

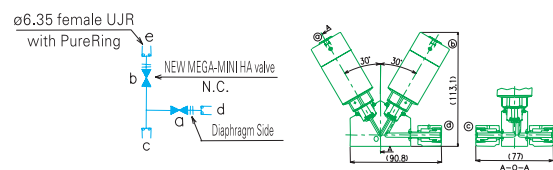

FBNSDV-721-6.35-2B3-316LP-BHI

\* A variety of configurations are possible. Please contact Fujikin for more information.

# NEW MEGA-MINI HM

## New Compact High-pressure Manual Valve

The NEW MEGA-MINI HM is a manual operation diaphragm valve for ultra-pure, flammable, or toxic fluid lines in semiconductor manufacturing equipment and facilities.

Direct diaphragm construction makes the NEW MEGA-MINI HM an industry standard valve with superior sealing performance, remarkable durability, compactness, and particle- and dead-space-free performance.







## Specifications and Materials

Specifications	Nominal Diameter	Maximum Operating Pressure	Fluid Temperature Range	Maximum Cv* (with N <sub>2</sub> gas at 20°C)	End Connection
	6.35	20.5 MPa	-10 to 40°C	0.1	UJR, UPG, tube stub

● Theoretical leak rate: External leak:  $< 5 \times 10^{-12}$  Pa·m<sup>3</sup>/sec. Seat leak:  $< 5 \times 10^{-12}$  Pa·m<sup>3</sup>/sec  
 ● Tested leak rate: External leak:  $< 5 \times 10^{-10}$  Pa·m<sup>3</sup>/sec. Seat leak:  $< 5 \times 10^{-10}$  Pa·m<sup>3</sup>/sec  
 \* Depends on the configuration of the body.

● All valves are helium leak tested.  
 ● Durability over 20,000 cycles under test conditions.

Materials	Part	Material
	Body	SUS316L (double-melt)
	Diaphragm	Nickel-cobalt alloy
	Seat Packing	PCTFE (standard)
	Handle	ADC12

Consult with Fujikin for use outside the specification range.

### Temperature/Pressure Rating

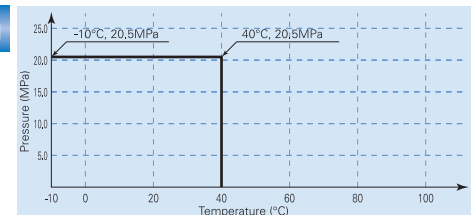

— PCTFE/Polyimide seat

## Part Number Designation

Please use the part number designations below when placing an order.

**FUNSD** [ ] -7 21G-6.35 [ ][ ] -316LP - [ ] - [ ]

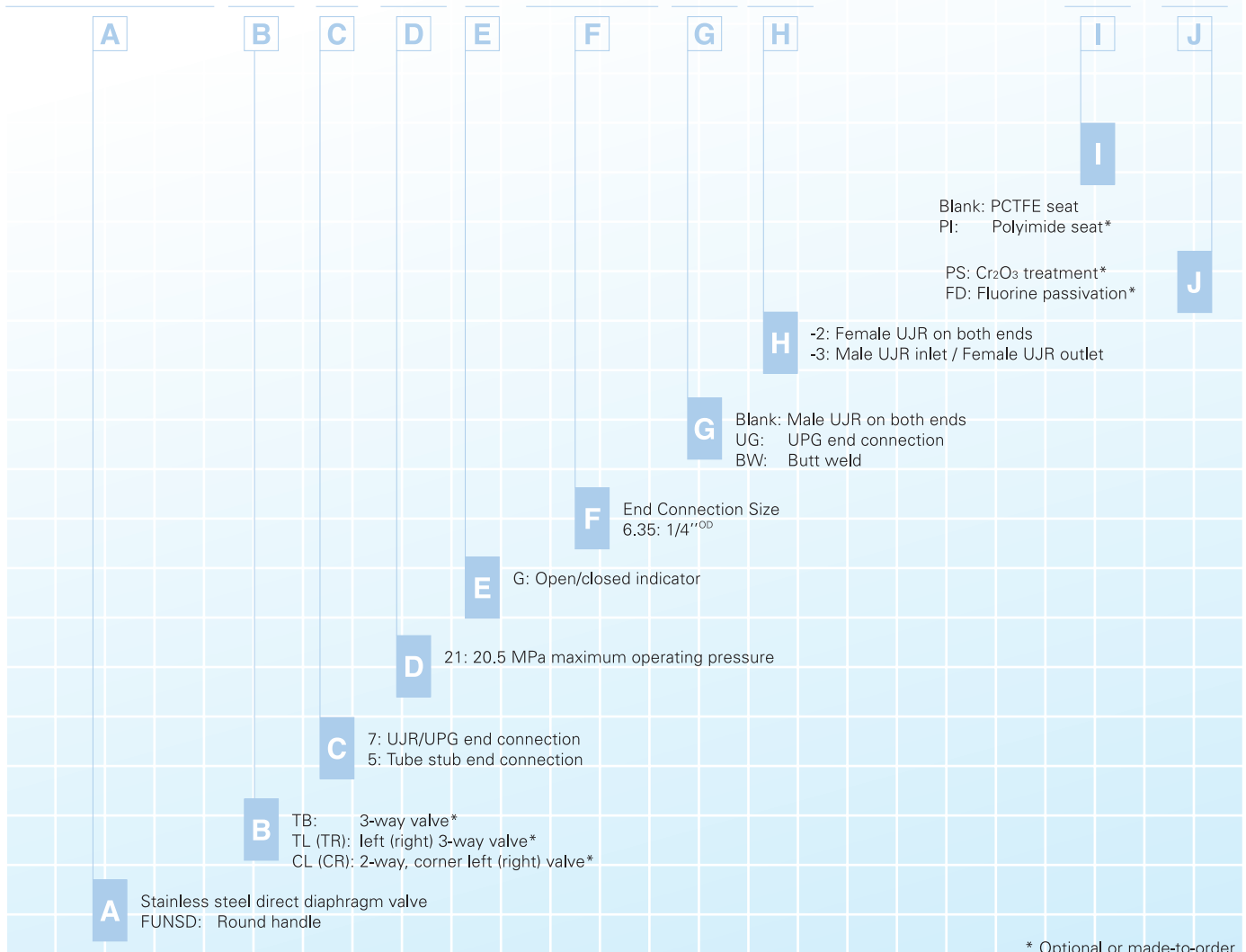

\* Optional or made-to-order.

Actual shipped items may have additional designations (such as #A, #B) in the part number. These indicate production history and do not indicate a change in function or dimensions.

## Dimensions

\* For the most up-to-date product information, visit Fujikin's website (<http://www.fujikin.co.jp/>).

Figure 1

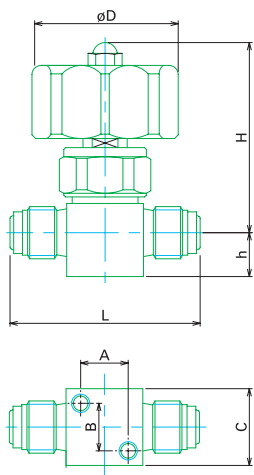

Figure 2

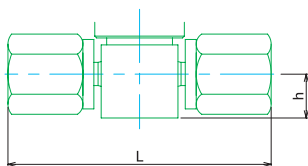

Figure 3

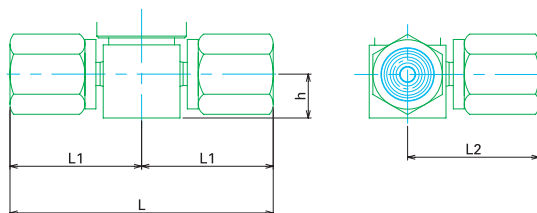

Figure 4

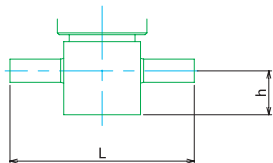

Figure 5

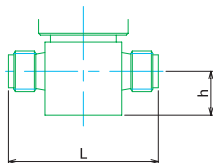
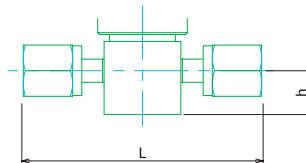

Figure 6



(Units: mm)

Part Number	Figure	L	L1	L2	L3	h	H	D	A	B	C
FUNSD-721G-6.35-316LP	1	52	-	-	-	11.1	52.3	40	13	13	21
FUNSD-721G-6.35-2-316LP	2	71.6	-	-	-	11.1	52.3	40	13	13	21
FUNSDTB-721G-6.35-2-316LP	3	71.6	-	-	35.8	11.1	52.3	40	13	13	21
FUNSD-521G-6.35BW-316LP-AWE	4	51	-	-	-	11.1	52.3	40	13	13	21
FUNSD-721G-6.35UG	5	41	-	-	-	11.1	52.3	40	13	13	21
FUNSD-721G-6.35UG-2	6	66	-	-	-	11.1	52.3	40	13	13	21

\* See Figure 1 for dimension keys not shown in other figures.

## OPTIONS

### High-pressure Gas Certification

Safety is assured for special high-pressure and toxic gas lines. This valve is tested and approved by the Japanese government agency that regulates high-pressure applications. The valve couplings (N-II) can also be certified and approved in the same manner.

Specific customer specifications may also be accommodated.

\* Use the order specification for recognized high-pressure gas products on page 33 to place orders.



The photos on this page depict examples of each product type.



Standard Configurations

\* Flow Diagrams (top view)

Corner Valves

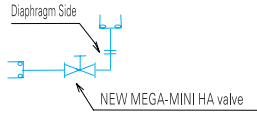

FUNSDCL-721G-6.35-2-316LP

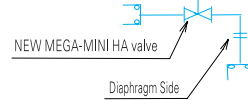

FUNSDCR-721G-6.35-2-316LP

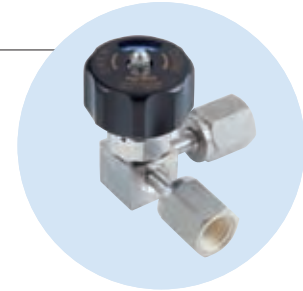

3-way Valves

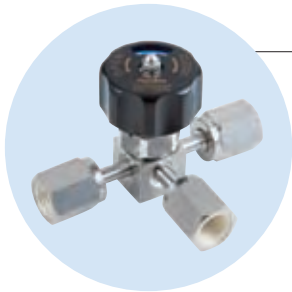

FUNSDTLO-721G-6.35-2-316LP

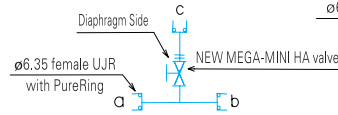

FUNSDTB-721G-6.35-2-316LP

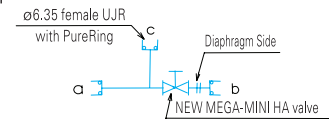
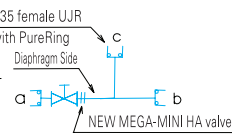

FUNSDTL-721G-6.35-2-316LP

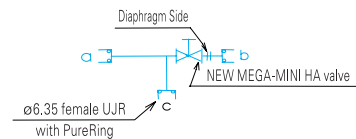

FUNSDTR-721G-6.35-2-316LP

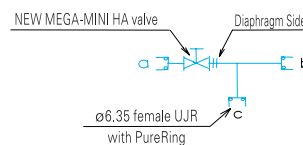

FUNSDTRO-721G-6.35-2-316LP

4-way Valves

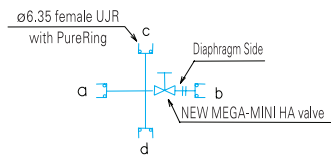

FUNSDXT-721G-6.35-2-316LP

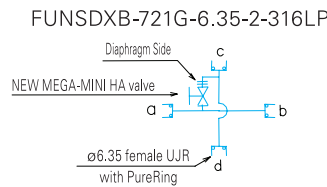

FUNSDXB-721G-6.35-2-316LP

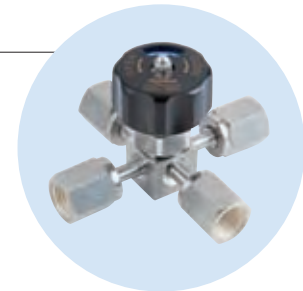

Quarter-turn High-pressure Switching Valve (Optional) NEW MEGA MINI HQ

This quarter-turn valve enables its open/closed position to be identified easily at a glance.



\* A variety of configurations are possible. Please contact Fujikin for more information.

## Additional Information

### ● Inner Surface Treatment

#### 1. Products with ULTRA EXTREME PURE (UP) Special Internal Treatment

By utilizing a special polishing technology to first remove work-affected and work-hardened layers from the metal surfaces, UP treated products attain a pure metal surface with an extremely uniform passivated film. The surface roughness is kept below 0.1  $\mu\text{m}$  Ra, with an average roughness of 0.1 mm or less. Additionally, final cleaning is performed in a Class 1 cleanroom to completely remove particles and impurities, and to assure a thoroughly clean product.

UP treatment is compatible with Hastelloy® and other corrosion-resistant materials.

UP treatment is standard with the MEGA-MINI and MEGA-M Series, and is optional with the MEGA-ONE® and NEW MEGA Series products.

#### 2. Products with Cr<sub>2</sub>O<sub>3</sub> Treatment (CRPS)

100% Cr<sub>2</sub>O<sub>3</sub> treated products have a film – a Cr<sub>2</sub>O<sub>3</sub> passivation layer – formed on the stainless steel surface through a special base layer treatment and heat treatment. This offers:

1. Superior corrosion resistance as compared to halogen-based gases.
2. Less outgassing of moisture, etc.: with the excellent dry-down characteristics of the material, equipment start-up time can be shortened.
3. Non-catalytic behavior is observed with hydrogen compound gases – such as SiH<sub>4</sub> and B<sub>2</sub>H<sub>6</sub> – which decompose at low temperatures through surface catalytic effect. This enables stable delivery to the point of use.

#### 3. Products with BK Treatment (CRPX)

BK treatment involves heat-treating the mirror-finish stainless steel surface in an inert gas environment. Components that undergo BK treatment are more corrosion resistant, evidence less outgassing, and have excellent dry-down characteristics.

#### 4. Products with Fluorine Passivation (FP)

FP products are given a chemically stable fluorine passivation layer through a reaction between the stainless steel surface and F<sub>2</sub> gas when heat treatment is applied. Recent advances in micro-fabrication technology and the increased use of excimer laser steppers have required an increase in F<sub>2</sub> use as well. Since F<sub>2</sub> gas is extremely reactive – and will react with stainless steel surfaces – it will be consumed and therefore affect the F<sub>2</sub> concentration. This, in turn, affects the oscillation frequency of the excimer laser.

### ● Seat Material

#### 1. PCTFE (Polychlorotrifluoroethylene)

Standard seat material in the MEGA-ONE®, MEGA-MINI and NEW MEGA Series products.

#### 2. PI (Polyimide) and PA (PFA)

A recommended option for non-standard temperatures and fluids.

### ● Permeation Leak across the Seat

Soft-sealing valves with resin seats may experience permeation leak, whereby gas diffuses through the resin. The degree to which leakage occurs varies according to factors such as the type of gas used, the fluid pressure, and the type of resin in the seat. Monitor accordingly. For more information, please contact Fujikin.

### ● Body and Diaphragm Material

Hastelloy®

For services that require exceptional corrosion resistance, Hastelloy C-22 may be specified as an optional material for valve bodies and diaphragms.

### ● Proximity Sensors and Limit Switches

When verification of open or closed position is required on pneumatically-actuated valves, proximity sensors or limit switches that output an electrical signal to an external unit are optionally available. Valves with a limit switch may be substituted for proximity sensor valves.

### ● Handle Colors

Handles may be specified in a wide variety of optional colors.



## NEW MEGA SERIES COMPARISON TABLE

		NEW MEGA-ONE®			NEW MEGA-MINI		
		LA	LS	LM	LA	HA	HM
Pressure Type	High Pressure					●	●
	High Pressure (Japan Certification)					▲	▲
Nominal Diameter	6.35	●	●	●	●	●	●
	9.52	●	●	●			
	12.7	▲*1	▲*1	▲*1			
Connection	UJR	●	●	●	●	●	●
	UPG	●	●	●	●	●	●
	F900	●	●	●			
	Tube Stub	▲	▲	▲	▲	▲	▲
Inner Surface Treatment	EP	●	●	●	●		
	UP	▲	▲	▲	▲	●	●
	CRPX	▲	▲	▲	▲	▲	▲
	CRPS	▲	▲	▲	▲	▲	▲
	FD	▲	▲	▲	▲	▲	▲
Body Material	SUS316L	●	●	●	●		
	SUS316L (Double-melt)	▲	▲	▲	▲	●	●
	Hastelloy®	▲	▲	▲	▲	▲	▲
Diaphragm Material	Nickel-cobalt Alloy	●	●	●	●	●	●
	Hastelloy®	▲	▲	▲	▲	▲	▲
Seat Material	PCTFE	●	●	●	●	●	●
	PI	▲	▲	▲	▲	▲	▲
	PA	▲	▲	▲	▲		
Other	Proximity Sensor						
	Limit Switch						
	Handle Color		▲	▲			▲

● : Standard feature

▲ : Optional









\* 1: Standard only when F900 is selected as the end connection.

## Part Number Designation

The part number varies according to valve configuration, flow direction, and end connections.

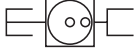
### 2-way Valves

Example : FPR-ND-71-6.35 **A**

A	Configuration (top view)	Flow Diagram (top view)
No Designation		
-2		
-3		
-4		





## Corner Valves

Example : FPR-NDCL-71-6.35 A

A	Configuration (top view)	Flow Diagram (top view)
No Designation		
-2		
-3		
-4		

Example : FPR-NDCR-71-6.35 A

A	Configuration (top view)	Flow Diagram (top view)
No Designation		
-2		
-3		
-4		



## Part Number Designation

The part number varies according to valve configuration, flow direction, and end connections.

### 3-way Valves

Example : FPR-NSDTB-71-6.35 A

Example : FPR-NSDTR-71-6.35 A

Example : FPR-NSDTL-71-6.35 A

A	Configuration (top view)	Flow Diagram (top view)
No Designation		
-2		
-3		
-4		
-5		
-6		
-7		
-8		

A	Configuration (top view)	Flow Diagram (top view)
No Designation		
-2		
-3		
-4		
-5		
-6		
-7		
-8		

A	Configuration (top view)	Flow Diagram (top view)
No Designation		
-2		
-3		
-4		
-5		
-6		
-7		
-8		





Example : FPR-NSDTRO-71-6.35 A

Example : FPR-NSDTLO-71-6.35 A

A	Configuration (top view)	Flow Diagram (top view)
No Designation		
-2		
-3		
-4		
-5		
-6		
-7		
-8		

A	Configuration (top view)	Flow Diagram (top view)
No Designation		
-2		
-3		
-4		
-5		
-6		
-7		
-8		

## Valves with High-pressure Gas Certification Specifications

Allocation No.				Attached Documents				
Serial No.								
Customer				Code No.				
End User *1				Code No.				
Target System Name *2				Type of Test Performed *3		High-pressure Certification Test High-pressure Recertification Test		
Equipment Category *3 *4 F: Reciprocating compressor, Z: Combined equipment, M: Tubing, E: Other pressure vessel				N: Valves, N-II: Fittings, O: Other		Delivery Date		
Product Number				Quantity				
Additions to Product Number		Drawing No.		End Connection Size				
Specifications	Normal Pressure (Maximum Operating Pressure)		MPa		Design Pressure		MPa	
	Design Temperature		MIN. °C to MAX. °C		Normal °C		Will this be used in vacuum conditions *3 Yes ( ) No ( Pa)	
	Type of Gas *3		Toxic, Flammable, Toxic and Flammable, Special High-pressure, Other					
	Name of Gas *3		Non-toxic Air, Nitrogen, Helium, Oxygen, Hydrogen, Carbon dioxide, Argon Other ( )					
	Special		Monosilane, Phosphine, Arsine, Diborane, Hydrogen selenide, Monogermane, Disilane					
	Toxic/flammable		Ammonia, Carbon monoxide, Other ( )					
	Toxic		Hydrogen chloride, Chlorine, Hydrogen bromide, Other ( )					
Material *3		SUS316 or SUSF316		SUS304 or SUSF304		SUS316L or SUSF316L		
						SCS14 C3604B C3771B Other ( )		
Other Special Specifications:			Target system has leak detector? *3		Yes / No		Valve used for toxic gas (special high-pressure gas) has a leak port? *3 Yes / No	
<p>Notes: (Fill in all items within bold lines.) *1: Enter the name of the product's end user. If the product will be delivered via a set/apparatus maker, please include their names also. *2: Enter the name of high-pressure gas system or processing equipment, etc. *3: Circle the one that applies. *4: Valves with threaded fittings to be used in high-pressure gas equipment for toxic gases (as per the General Provision, Article 2-2) are subject to identification as one of the following categories: N (valves) or N-II (fittings). If applicable, circle both N and N-II. (Circle only Z (combined equipment) if within the specification range of Z (combined equipment)).</p>								
Order No.		Comments from Factory Personnel:						
Project No.								
Spec. No.								
Documents Submitted			*3 Destination (Products & Documents)					
(1) Test Report (Authorized Tester)		1 copy		Sales Office				
(2) Test Certificate (N-II excluded)		Copies		Send directly to:				
(3) Instruction Manual (N-II only)		Copies						
(4) Other								
·Delivery Specifications		Copies						
·Mill Certificate		Copies						
·Calculations of Wall Thickness Strength								
·Fujikin Design Specification (standard)		Copies						
·Design Specifications		Copies						
·Inspection Procedures		Copies						
Seal of Approval		Sales Representative		C T D		T D C		